

European Technical Assessment

ETA 06/0237

Version 01

Date of issue: 2017-09-03



UBAtc Assessment Operator:
Belgian Construction Certification Association
Rue d'Arlon 53 - 1040 Brussels
www.bcca.be - info@bcca.be



Technical Assessment Body issuing the European Technical Assessment: UBAtc.
UBAtc has been designated according to Article 29 of Regulation (EU) No 305/2011
and is member of EOTA (European Organisation for Technical Assessment)

Trade name of the construction product:	CW 50-SG
Product family to which the construction product belongs:	9 - Structural sealant glazing kit for use in curtain walling
Manufacturer:	Reynaers Aluminium N.V. Oude Liersebaan 266, B-2570 Duffel Belgium
Manufacturing plant:	Reynaers Aluminium N.V. Oude Liersebaan 266, B-2570 Duffel Belgium
Website:	www.reynaers.com
This European Technical Assessment is issued in accordance with Regulation (EU) No 305/2011, on the basis of:	ETAG 002, edition 1999 amended in 2012, used as European Assessment Document (EAD)
This version replaces:	European Technical Approval 06/0237, issued on 4 September 2012
This European Technical Assessment contains:	27 pages, including 1 annex which forms an integral part of the document



European Organisation for Technical Assessment

Legal bases and general conditions

1. This European Technical Assessment is issued by UBAtc (Union belge pour l'Agrément technique de la construction, i.e. Belgian Union for technical Approval in construction), in accordance with:
 - Regulation (EU) N° 305/2011¹ of the European Parliament and of the Council of 9 March 2011 laying down harmonised conditions for the marketing of construction products and repealing Council Directive 89/106/EEC
 - Commission Implementing Regulation (EU) N° 1062/2013² of 30 October 2013 on the format of the European Technical Assessment for construction products
 - Guideline for European technical approval 002 (ETAG), used as European Assessment Document (EAD)
2. Under the provisions of Regulation (EU) No 305/2011, UBAtc is not authorized to check whether the provisions of this European Technical Assessment are met once the ETA has been issued.
3. The responsibility for the conformity of the performances of the products with this European Technical Assessment and the suitability of the products for the intended use remains with the holder of the European Technical Assessment.
4. Depending on the applicable Assessment and verification of constancy of performance (AVCP) system, (a) notified body(ies) may carry out third-party tasks in the process of assessment and verification of constancy of performance under this Regulation once the European Technical Assessment has been issued.
5. This European Technical Assessment allows the manufacturer of the construction product covered by this ETA to draw up a declaration of performance for the construction product.
6. CE marking should be affixed to all construction products for which the manufacturer has drawn up a declaration of performance.
7. This European Technical Assessment is not to be transferred to other manufacturers, agents of manufacturers, or manufacturing plants other than those indicated on page 1 of this European Technical Assessment.
8. The European Technical Assessment holder confirms to guarantee that the product(-s) to which this assessment relates, is/are produced and marketed in accordance with and comply with all applicable legal and regulatory provisions, including, without limitation, national and European legislation on the safety of products and services. The ETA-holder shall notify the UBAtc immediately in writing of any circumstance affecting the aforementioned guarantee. This assessment is issued under the condition that the aforementioned guarantee by the ETA-holder will be continuously observed.
9. According to Article 11(6) of Regulation (EU) N° 305/2011, when making a construction product available on the market, the manufacturer shall ensure that the product is accompanied by instructions and safety information in a language determined by the Member State concerned which can be easily understood by users. These instructions and safety information should fully correspond with the technical information about the product and its intended use which the manufacturer has submitted to the responsible Technical Assessment Body for the issuing of the European Technical Assessment.
10. Pursuant to Article 11(3) of Regulation (EU) N° 305/2011, manufacturers shall adequately take into account changes in the product-type and in the applicable harmonised technical specifications. Therefore, when the contents of the issued European Technical Assessment do not any longer correspond to the product-type, the manufacturer should refrain from using this European Technical Assessment as the basis for their declaration of performance.
11. All rights of exploitation in any form and by any means of this European Technical Assessment is reserved for UBAtc and the ETA-holder, subject to the provisions of the applicable UBAtc regulations.
12. Reproduction of this European Technical Assessment including transmission by electronic means shall be in full. However, partial reproduction can be made with the written consent of UBAtc. In this case partial reproduction has to be designated as such. Texts and drawings of advertising brochures shall not contradict or misuse the European Technical Assessment.
13. Subject to the application introduced, this European Technical Assessment is issued in English and may be issued by the UBAtc in its official languages. The translations correspond fully to the English reference version circulated in EOTA.
14. This European Technical Assessment, ETA 06/0237, was first issued on 3 September 2017 and replaces European Technical Approval, ETA 06/0237, issued on 4 September 2012.

¹ OJEU, L 88 of 2011/04/04

² OJEU, L 289 of 2013/10/31

Technical Provisions

1 Technical description of the product

1.1 Characteristics of the product

1.1.1 General

This ETA is being issued for the products specified on the cover page on the basis of agreed data/information, deposited with the UBAtc, which identifies the products that have been assessed and judged. Changes to the product/production process, which could result in the deposited data/information being incorrect, should be notified to the UBAtc before the changes are introduced. The UBAtc will decide whether or not such changes affect the ETA.

1.1.2 Structural sealant glazing kit

Structural sealant glazing kit (SSGS) in which the glazing infills are bonded all along the perimeter with a structural sealant to a metallic structural sealant support frame.

The CW 50-SG kit is of the type I or II as per ETAG 002, table 1.

1.2 Components of the kit

1.2.1 Structural sealants

The kit comprises the following structural sealants

Table 1 – Structural sealants

Glass on anodised aluminium		
Dow Corning	DC 993	ETA 01/0005
	DC 895	ETA 01/0005
Kömmerling	Ködiglaze S	ETA 08/0286
Sika	SG 500	ETA 03/0038
	SG 20	ETA 06/0090
Tremco	Proglaze II	ETA 05/0006
	VEC 90	ETA 05/0005
	VEC 99	ETA 05/0005
Outer structural edge seal of the insulating glass unit		
Dow Corning	DC 3362	ETA 03/0003
Kömmerling	GD 920	ETA 08/0004
Sika	IG 25	ETA 05/0068

Generic and specific types of suitable substrates for adhesion to the structural sealants are given in the ETA of the structural sealants

1.2.2 Structural sealant support frame

Framing profile Fig. 1

- Fixed frame:
 - 034.0161.XX + adaptor 034.1116.17;
 - 034.0165.XX + adaptor 034.1116.17 + panel fixing bead 030.3864.XX
 - 034.0166.XX + adaptor 034.1116.17 + panel fixing bead 030.3864.XX
 - 034.0167.XX + adaptor 034.1116.17 + panel fixing bead 030.3864.XX
- Opening light:
 - Fixed frame for opening part: 034.0162.XX;
 - Opening light profile: 034.0163.XX + adaptor 034.1116.17

The structural sealant support frame is made out of aluminium alloy in accordance with Table 2.

Table 2 - aluminium alloy - characteristics

Alloy	Metallurgic state	Mechanical characteristics
Designation		
EN 573-3	EN 515	EN 755-2
EN AW-6060	T66	

Table 3 - Anodising characteristics of the structural sealant adhesion surface

Characteristics	Method	Criteria EOTA	Nominal value
Thickness	EOTA, clause 5.2.2.1.1	Mean minimum thickness: 15µm	≥ 20 µm
Sealing :			
Sealing degree			
Weight lost	EOTA, clause 5.2.2.1.2	EN ISO 3210: < 30 mg/dm ²	< 30 mg/dm ²
Admittance at 1.000 Hz for a given thickness of 20 µm	EOTA, clause 5.2.2.1.3	EN ISO 2931: < 20 µS	< 20 µS
Stain test		EN ISO 2143: < 2 on Qualanod scale	0-1

The anodising of the structural adhesion surface adaptor profile 034.1116.17 is performed by the firm Alural (Be), Alcan (Fr), Effector (PI) and Final (PI).

Geometrical and weight characteristics:

- Wall thickness of the profiles: 1,5 to 2 mm, tolerances conforming to EN 12020 –1 and- 2
- External dimensions of the profiles: (cf. fig. 1): tolerances: EN 12020 –1 and- 2
- Nominal linear mass (tolerances: + 10 %; - 10 %)
- Inertia: axes: xx parallel to the glazing, yy perpendicular to the glazing.

Table 4 - Geometrical and weight characteristics:

Profiles	I_{xx} (mm ⁴)	I_{yy} (mm ⁴)	Linear mass. Kg/m.
034.0161.XX	27910	32660	0,759
034.0162.XX	231280	106750	1,208
034.0163.XX	266600	195360	1,519
034.0165.XX	71480	20050	0,742
034.0166.XX	84240	20060	0,759
034.0167.XX	108220	20060	0,786

1.2.3 Profiles and complimentary accessories

1.2.3.1 Mechanical self-weight support (fig. 2)

The mechanical self-weight support are listed in the following table

Articles	Application	Articles	Application
073.7290.39	Double glazing	073.7292.39	Double glazing
073.7291.39	Double glazing	073.7293.39	Single glazing

Table 5 - Mechanical self-weight support

Mechanical self-weight support: length 100 mm, fixed by 2 screws ref 051.5282, DIN 916 M4x8.

The support of the glass relies on the use of setting blocks, which transfer the glass dead load to the mechanical self-weight support.

Those devices are calculable according to the standardised loading using conventional calculations based upon the strength of material. Taking into account a safety factor on aluminium $\gamma_m = 1,1$; a maximum pressure on glass of 1 MPa and a maximum vertical displacement between the 2 glass pane of 1 mm, the bearing capacity of the devices is given in this ETA, clause 2.3.1.5.

1.2.3.2 Retaining device (fig. 3)

The retaining devices are made of aluminium AW 6060 T66 according EN 755-2.

Retaining devices are means of retaining the glass to reduce danger in the event of sealant failure.

The necessity of these accessories is to be evaluated in function of the safety specifications, of the situation of the building and of its working condition.

Those devices are calculable according to the standardised loading using conventional calculations based upon the strength of material. Taking into account a safety factor on aluminium $\gamma_m = 1,1$ and of a maximum pressure on glass of 1 MPa, the bearing capacity of the devices is given in this ETA, clause 2.3.1.7.

Retaining device: Article: 073.7280.39, 073.7282.39, 073.7284.39, 073.7278.39

1.2.3.3 Anchorage of the structural sealant support frame on the façade structure (fig. 4)

The anchorage is composed of mill finished aluminium AW 6060 T66 according EN 755-2.

Cotters:

- 034.0130.00; 034.0138.00; 034.0143.00; 034.0146.00; 034.0144.00; 034.0147.00; 034.0145.00; 034.0148.00; 034.0175.00; ; 034.0176.00 screwed with article n°053.5461 – EN ISO 3506 $\Phi 6,3$ mm length 22 mm with hexagonal hollow head in stainless steel
- *In case of dilatation*, anchorage 034.0175.00 and 034.0176.00 are used instead of 034.0130.00 and 034.0138.00

The bearing capacity of the anchorage is given in this ETA, clause 2.3.1.6

1.2.3.4 Other devices (fig. 5)

- Corner to crimp for the structural sealant support frame of the fixed glazing: 068.7320.00
- Corner to crimp for the structural sealant support frame (vent of the opening part) 068.7300.00
- Corner to crimp (frame of opening part: 068.7300.00 + corner for rebate reinforcement: 060.7722
- Corners for the support frames single glazing: 068.6094.00, 068.6109.00

1.2.4 Insulating glass unit

The kit CW 50-SG is designed in such way that the IGU outer edge seal is a structural edge seal. The outer seal shall be performed with the structural sealant in Table 1 with a minimum bite of 6 mm.

IGU's shall conform to the ETAG 002, clause 5.0.

For each project, the IGU's manufacturer shall deliver to the façadier a technical dossier as described in ETAG 002, clause 8.3.2.4 (vi).

Dimensional tolerances on the IGU: ± 2 mm on the glass pane, special care shall be taken that the glass is always in contact with the settings blocks.

1.2.5 Cleaning product

The cleaning product that has to be used to clean the façade is mentioned in the ETAs for structural sealants.

Other products may be used provided they are assessed for conformity to ETAG 002, clause 5.2.3.3.

1.3 Accessories

1.3.1 Gasket fig. 6

1.3.1.1 Gaskets support between glazing units

The ABS gaskets supports 034.0170.04, 034.0171.04 are clipped on the cotter.

1.3.1.2 EPDM gaskets

- 080.9810.04 – 080.9871.04 - 080.9812.04 080.9815.04 – 080.9876.04 – 080.9817.04 080.9360.04: The gaskets are used to ensure the air and water tightness between the frame and the opening light and between the frame and the façade structure:
- 080.9740.04; 080.9741.04; 080.9742.04 – EPDM glazing gaskets
- 080.9514.04; 080.9515.04 – EPDM gasket for angle glazing
- 080.9801.04 - EPDM butt gasket for fixed frame profiles
- 080.9937.04; 080.9938.04 - EPDM pressure gasket to be used between 2 structural sealant support frames to ensure the air and water tightness.
- 080.9300.04 - EPDM gasket to be used as spacer on fixed profile for structural seal
- 080.9303.04 - EPDM gasket to be used as spacer on opening light profile for structural seal
- 080.9444.04; 080.9453.04 - EPDM gasket to insure air and water tightness between fixed profile and opening light profiles.

1.3.2 Backer rod

PE-foam from the firm Castelein Sealants

1.3.3 Sealant

In function of the structural glazing sealants chosen for the projects, the corresponding compatible weather sealants of the same sealant supplier shall be applied when the products are in contact. The compatible sealants tested are Dow Corning - DC 791, Sika - 605, Tremco - Proglaze LMA and Kömmerling - GD 826N.

1.3.4 Iron work (fig. 9 and 10)

Top hung window: Friction stays:

- REYNAERS 021.5640.--; 021.5650.--; 021.5660.--; manufactured by Bezault Italinnox 400R – 500R – 600R
- Reynaers 060.8370.-- manufactured by Securistyle SPT26 with adjustment piece S7280.

1.3.5 Setting and location blocks

The glazing dead load is transferred setting blocks, with the following characteristics. In function of the structural glazing sealants chosen for the project, setting and location blocks are specified in the ETA of the structural sealant. The length of the setting block are to be adapted as a function of glazing load.

2 Specification of the intended use(s) in accordance with the applicable EAD

2.1 General

Structural sealant glazing kit (SSGS) for use as a façade or parts thereof. The structural sealant support frame consists of opening light frame profiles held in a fixed frame by ironwork which is anchored to the façade structure by means of screws to form a curtain walling. The façade structure is not a part of the present ETA.

The system is intended to be used in curtain walling for which requirements ER2 Safety in case of fire, ER3 Hygiene, health and environment, ER4 Safety in use, ER5 Protection against noise and ER6 Energy economy and heat retention may be fulfilled. The failure of the structural bond would cause risk to human life and/or considerable economic consequences.

The provisions made in this European Technical Assessment are based on the assumed working life of the SSGS of 25 years. The assumed working life of a system cannot be taken as a guarantee given by the producer, but are to be used as a means for selecting appropriate products.

2.2 Provisions related to manufacturing, packaging and storage

2.2.1 Storage of the anodised Glazing profile adaptor 034.1116.17.

The storage of the glazing profile shall be performed in a protected and maintained location with a maximum relative humidity of 60%. At those conditions, they may be used for projects up to 6 months after the anodising. After this delay, the adaptors need to be reassessed.

2.2.2 Structural sealant support frames (fig. 7)

The structural sealant support frames are manufactured by the façadiers according to the ETA designer rules and instructions.

The structural sealant support frame profiles are made of extruded aluminium.

The profiles are assembled by corners to screw and/or to clamp to form the structural sealant support frame:

The dimensional tolerances on the structural sealant support frame are ± 1 mm.

Principal operations:

- Assembling of the structural seal support frame profile,
- Drilling and punching of the holes for ironwork, drainage and ventilation
- Setting the ironwork

2.2.3 Bonding the glazing

The following combinations of anodizing/sealant has been assessed fit for use.

The use of primer is assessed per batch of adaptor by adhesion test with the project structural sealant(s)

Sealants	Anodizing	Cleaner/Primer
DC 993	Alural	Cleaner DC 40
	Effector	
	Final	
	Alcan	
DC 895	Alcan	
	Alural	

Sealants	Anodizing	Cleaner/Primer
SG500	Alural	
	Alcan	
SG20	Alural	
	Alcan	
VEC 99	Alcan	Primer 10073
	Alural	
VEC 90	Alcan	
	Alural	
Proglaze II	Alcan	Primer 10
	Alural	
Kodiglaze	Alural	Korasolv GL/ Korabond HG 78

Table 6 – Sealant-anodizing combinations

2.2.3.1 Application of the sealants

This work is performed in a workshop heated and maintained free from dust. Instructions given in the ETA for structural sealant are to be respected.

Principal stage of assembling:

- Preparation of the structural sealant adhesion surfaces as prescribed by the ETA on the structural sealant(s) used,
- Setting in place of the spacers,
- Setting in place of the glazing,
- Setting of setting blocks in place,
- Extrusion of the sealant,
- Pressing and smoothing the sealants beads,
- Setting of the mechanical self-weight support

The frame is immediately set on a rack. The sealant curing is then allowed without any movement between the glass and the structural support frame during the time prescribed in the structural sealant ETA.

2.3 Provisions related to the design and use of the product

2.3.1 Design rules

2.3.1.1 Structural seals design

The structural seal shall be calculated in accordance with ETAG 002, Annex 2, with the design value given in chapter 2.1.1 respecting the following the minimum dimensions of the structural seal are $e \geq 6$ mm, $h_c \geq 6$ mm. (For the definition of e , h_c , r , see ETAG 002).

Alternative calculation methods mentioned in the ETA of the structural sealants may also be used (see this ETA, clause 1.2.1).

2.3.1.2 Drainage (fig. 8)

- Drainage of the fixed parts is performed by cutting away the lips of the pressure gasket (080.9937.04 or 080.9938.04) over the length of the glass support. For the single glazing parts, an extra slot hole 4x25 mm is made through the low horizontal part of the structural sealant support frame and gasket 080.9801.04
- Drainage of the opening parts is performed by cutting away the lips of the pressure gasket (080.9937.04 or 080.9938.04) over the length of the glass supports.
- Ventilation of the fixed parts is performed by 2 holes of $\varnothing 6$ mm in the upper part of the 2 vertical structural sealant support frame profiles.

2.3.1.3 Weather sealing

The weather sealing is achieved as follow

- Fixed parts: The weather sealing is achieved with a horizontal or vertical glazing gasket between the CW 50 structure and the sealant support frame, and a pressure gasket 080.9937.04 or 080.9938.04 in between the glass panels.
- Opening parts: The weather sealing is achieved with 2 seal gaskets 080.9444.04 in between the frame and vent. The pressure gasket 080.9937.04 or 80.9938.04 is used in between glass panels.

2.3.1.4 Maximum dimensions

Opening lights: 1750 x 1750 mm determined as a result of the test on façade prototype.

Fixed parts: The fixed parts are to be calculated according the technical data of the anchorages and frame profile given in the ETA

Anchorage of the structural sealant support frame: the fixed frames are designed taking into consideration the following rules:

- The structural sealant cross-section must be calculated as per annex 2 of the ETAG 002 SSGS under ultimate limit state loads combinations (ULS).
- The bearing capacity of an anchorage of the structural support frame on the façade structure is $F_{des} = 630$ N partial factor of 2 included
- The maximum deflection of structural sealant support frame profile between 2 anchorages is 1/300.
- Special care shall be taken to the blocking of the glazing to structural sealant support frame profiles and to the blocking of the structural support frame on the transom of the façade structure.

2.3.1.5 Transfer of the dead load of the infill panel to façade structure (for fixed part and opening light)

The mechanical self-weight support devices are given in this ETA, clause 1.2.3.1

Table 7 – Self weight support - maximum bearing capacity

Retaining device	Maximum bearing capacity N
073.7290.39, length 100 mm (IGU)	1500
073.7291.39, length 100 mm (IGU)	1200
073.7292.39, length 100 mm (IGU)	900
073.7293.39, length 100 mm (single glass)	3500

While installing the structural sealant support frame on site, special care is to be taken to block the structural sealant support frame on the façade structure in order to transfer correctly the dead load.

2.3.1.6 Transfer of the wind load to the façade structure

The wind load is transmitted to the façade structure via aluminium cotters mentioned in this ETA, clause 1.2.3.3 screwed with M6 screws length 22 mm with hexagonal hollow head in stainless steel

The number of screws is determined taking into account of the following rules:

- the maximum distance between two screws is 150 mm
- the maximum deflection of the profile between two anchorages is 1/200
- the structural sealant support frames are equipped with at least four anchorages

taking into account a safety factor of 2, the bearing capacity of a single anchorage is $F_{des} = 630$ N (ETAG, clause 5.1.4.3.2, Method II)

2.3.1.7 Retaining devices

The retaining devices are given in this ETA, clause 1.2.3.2. The maximum bearing capacity of the retaining device is given here after

Table 8 - Retaining device - maximum bearing capacity

Retaining devices 100 mm	Bearing capacity F_{des} (N)	Retaining devices 100 mm	Bearing capacity F_{des} (N)
073.7280.39	440	073.7284.39	440
073.7282.39	440	073.7278.39	440

Calculation of the length must be done project per project in function of the wind and the infill panel dimensions

2.3.1.8 Ironwork

As a function of the glazed element size, the number of locks of the ironwork is given in figure 10.

2.3.2 Installation - Specifications on the façade structure

The maximum permissible deflection of the mullion and transom under the designed load is 1/200 (SLS).

The coupling between mullions and transoms is performed by mechanical T -connection.

The façade structure shall be electrically earthed.

The façade structure shall be equipped with dilatation joints and movement joints in function of those of the building structure.

In the façade design, movement in the joint shall not be thwarted and care shall be taken no to shortcut any façade structure joint with structural sealant support frames.

The structural sealant support frames are placed in the façade structure element per element.

The elements are then equipped with the gaskets.

Care shall be taken to allow drainage.

2.3.3 Maintenance and repair

2.3.3.1 Repair

All damages noticed on a structural sealant shall be repaired as follows:

- dismantling of the structural sealant support frame
- replacement by a new unit in reserve
- repair of the damaged unit in workshop following the procedure described in this ETA, clauses 2.2 and 2.3, after removing of the structural sealant.

2.3.3.2 Maintenance

Current maintenance: cleaning up the glazing with clear water.

When necessary, the cleaning product mentioned in the ETAs for structural sealants referred in Table 1 can be used.

For any other cleaning product, the compatibility with the kit shall be assessed as required by the ETAG 002.

3 Performance of the product and references to the methods used for its assessment

3.1 General

The assessment of the fitness for use of the structural sealant for the intended use in relation to the requirements for safety in case of fire; safety in use; hygiene health and environment; energy economy and heat retention; in the sense of the Essential Requirements 2, 3, 4 and 6, has been made in accordance with the "Guideline for European Technical Assessment for Structural Sealant Glazing Systems (ETAG 002).

Where the guideline allows for classifications and/or choice, the selection specified below has been made.

3.2 ER2 Safety in case of fire

3.2.1 Reaction to fire

No performance assessed

3.2.2 Resistance to fire

No performance assessed

3.3 ER3 Hygiene, health and environment

3.3.1 Air permeability (ETAG 5.1.3.1.2, EN 12152)

Table 9 – Air permeability

Type of opening	ETAG 002, clause 5.1.3.1.2 EN 12152 – EN 12207
Fixed part	Class A4
Top Hung window - Friction stays	Class 4

3.3.2 Water tightness (ETAG 5.1.3.1.2)

Table 10 – Watertightness

Type of opening	ETAG 002, clause 5.1.3.1.2 EN 12154 – EN 12237
Fixed part	RE 1200
Top Hung window - Frictions Stays	E 1200

3.3.3 Dangerous substances

No performance assessed

3.4 ER4 Safety in use

3.4.1 Impact test

No performance assessed

3.4.2 Racking, torsion and operating forces

No performance assessed

3.4.3 Sill height

Transom and mullion are coupled by mechanical T shear connection.

The sill height can be adapted to any required height.

3.4.4 Wind resistance

Table 11 – Wind resistance

Type of frame	ETAG 002, clause 5.1.4.9 EN 13116:
Fixed part	Design load: 2000 Pa (SLS) Wind load safety : 3000 Pa (ULS)
Top Hung window - Frictions Stays	EN 12210 : C4

3.5 ER5 Protection against noise:

3.5.1 For fixed part

Table 12 - Acoustic performances – fixed parts

Description	Fixed part			
	(lg x h) (m) 4x1,96x1,2 surface: 9,42m ²	(lg x h) (m) 4x1,96x1,2 surface: 9,42m ²	(lg x h) (m) 4x1,96x1,2 surface: 9,42m ²	(lg x h) (m) 4x1,96x1,2 surface: 9,42m ²
Mullion	034.1505	034.1505	034.1505	034.1505
Transom	034.1524	034.1524	034.1524	034.1524
Struct. seal support frame	034.0161	034.0161	034.0161	034.0161
Adaptor	034.1116	034.1116	034.1116	034.1116
glass / infill	6/12/6	55.2/18/6	44.2/14/66.2 stratophone	(*)
Tightness	Gaskets	Gaskets	Gaskets	Gaskets
R _w (C; C _{tr})	33(-1;-4)	40(-2;-7)	43(-2;-6)	60(-2;-6)

(*) Glass 6mm - Air gap 22,7 mm - steel: 1,5mm - min wool: 20 mm 135 kg/m³ - steel: 1,5mm - Air gap 23 mm - min wool: 60 mm 80 kg/m³ - min wool: 60 mm 50 kg/m³ - steel: 1,5mm - Gypsum board: 12,5 mm

3.5.2 For opening part type (outward projecting)

Table 13 – Acoustic performances – opening parts

Description	Opening part		
	(lg x h) (m) 1,23x 1,48	(lg x h) (m) 1,23x 1,48	(lg x h) (m) 1,23x 1,48
Mullion	034.1502	034.1502	034.1502
Transom	034.1522	034.1522	034.1522
Adaptor	034.1116	034.1116	034.1116
fixed profile	034.0118	034.0118	034.0118
Vent profile	034.0119	034.0119	034.0119
glass / infill	6/15/6	55.2/18/6	44.2/14/66.2 stratophone
Tightness frame - window	Gaskets	Gaskets	Gaskets
Ironwork	8 locking points (2 each sides) + 2 friction stays	8 locking points (2 each sides) + 2 friction stays	8 locking points (2 each sides) + 2 friction stays
R _w (C; C _{tr})	36(-2;-5)	42(-2;-5)	44(-2;-5)

3.6 ER6 Energy economy and heat retention

3.6.1 Determination of thermal insulation and susceptibility of condensation:

- Aggregate test method

No performance assessed through testing

- Calculation method:

As a function of the design and the glazing chosen, thermal modelling of a SSGS can be undertaken with various computer software packages. To use the results of those programmes, it is necessary to ensure that they are at least two-dimensional and cover all the required parameters (EN ISO 13788).

- The commonly used values of the thermal conductivity (λ -value) of the materials used in the present SSGS kit are

Table 5 - Thermal conductivity (λ -value) of the components

Materials	λ -value (W/m K)	Materials	λ -value (W/m K)
Stainless steel	17	Silicone	0,35
Glass	1	Spacer PUR foam	0,078
EPDM	0,25	Aluminium	160
ABS	0,15	TPE LD	0,33

Some situation has been calculated as per EN ISO 10077-2 based on the assumption of the EN ISO 12361. The total width of the joint is 190 mm, considering an infill panel of 1,4 W/m²K or single glass.

Results of calculation

Table 14 – U-value of typical joints

Joint between	Infill panel Ug	U-value (W/m ² K)	ψ (W/m ² K)
Fixed element + fixed element		7,36	1,39
Opening part (friction stays) + fixed element	1,4	5,64	1,07
2 Opening parts (Friction stays)		4,65	0,88

4 Assessment and verification of constancy of performance (AVCP) system applied, with reference to its legal base

In accordance with Regulation (EU) N° 305/2011, Article 65, Directive 89/106/EEC is repealed, but references to the repealed Directive shall be construed as references to the Regulation.

The systems of assessment and verification of constancy of performance specified by the European Commission detailed in EC Decision 96/582/EC³ are as follows:

- System 1 (without audit testing of samples) for SSG kits Type II and IV;
- System 2+ (first possibility, including certification of the factory production control (FPC) by an approved body on the basis of its continuous surveillance, assessment and assessment) for SSG kits Type I and III

The system(s) of assessment and verification of constancy of performance are shown in the following Table.

Table 15 – System(s) of assessment and verification of constancy of performance

Product(s)	Intended use(s)	Level(s) or class(es)	Assessment and verification of constancy of performance system(s)*
Structural sealant glazing kits type II and IV	External walls and roofs	none	1
Structural sealant glazing kits type I and III		none	2+

* See Annex V to Regulation (EU) N° 305/2011

In practice, the operation of systems 1 and 2+ will be very similar for SSG kits, for the following reasons:

- the results of assessment testing shall be used by notified bodies (cf. Regulation (EU), Annex V, clause 1.6)
- the nature of the product is such that testing of samples at the factory by the manufacturer will be required under the FPC arrangements.

³ Commission decision of 24/06/96, published in the EC Official Journal L254 of 08/10/96

5 Technical details necessary for the implementation of the AVCP system

5.1 Tasks for the ETA-holder

5.1.1 Factory production control (FPC)

5.1.1.1 General

The manufacturer shall establish, document and maintain a FPC system to ensure that the products placed on the market conform to the stated performance characteristics. The FPC system shall consist of procedures, regular inspections and tests and/or assessments and the use of the results to control raw and other incoming materials or components, equipment, the production process and the product.

A FPC system conforming with the requirements of EN ISO 9001, and made specific to the requirements of this ETA, is considered to satisfy the above requirements.

The results of inspections, tests or assessments requiring action shall be recorded, as shall any action taken. The action to be taken when control values or criteria are not met shall be recorded.

The ETA holder of the kit is responsible for setting up appropriate rules and instructions for façadiers and the bonding workshops (quality manual for kit assembling and bonding). The different actors are bound via contractual links with the ETA holder to respect the kit holder's rules and instructions which are an integral part of the FPC system

5.1.1.2 Equipment

All weighing, measuring and testing equipment shall be calibrated and regularly inspected according to documented procedures, frequencies and criteria.

5.1.1.3 Raw materials and components

The specifications of all incoming raw materials and components shall be documented, as shall the inspection scheme for ensuring their conformity.

5.1.1.4 Non-conforming products

In the event of any non-conformity of any product, that product shall be placed into quarantine and action taken to rectify the cause of the non-conformity. Products may not subsequently be dispatched until the problem has been resolved.

5.1.1.5 Tests and frequencies

All the elements, requirements and provisions adopted by the manufacturer are documented in a systematic manner in the form of written policies and procedures. This production control system ensures that the product is in conformity with the European Technical Assessment (ETA).

This relates only to taking samples representative of the final product. In the context of SSGS the testing of "H" pieces, peel tests as part of FPC provides the necessary evidence.

5.2 Tasks for the Technical Assessment Body

5.2.1 Initial Type Testing

Assessment tests on the sealant have been conducted under the responsibility by the assessment body (UBAtc) in accordance with Chapter 5 of the ETAG 002. The assessment body (UBAtc) has assessed the results of these tests in accordance with Chapter 6 of this ETAG, as part of the ETA issuing procedure. The results of assessment testing shall be used by notified bodies (cf. Regulation (EU), Annex V, clause 1.6).

5.2.2 Assessment of the factory production control - Initial inspection and continuous surveillance

Assessment of the FPC is the responsibility of a notified body.

An assessment must be carried out on the required manufacturing steps of each manufacturing plant to demonstrate that the factory production control is in conformity with the ETA and any subsidiary information. This assessment is based on an initial inspection of the different manufacturing actors' plants. (Kit designer; façadier(-s) and bonding workshops)

Subsequently continuous surveillance of factory production control is necessary to ensure continuing conformity with the ETA. This continuous surveillance shall be in conformity with ETAG 002, chapter 8.3, at each identified manufacturing plant.

It is recommended that surveillance inspections should be conducted at least twice a year at each identified manufacturing plant.

6 Bibliography

ETAG 002 Structural sealant glazing kits Edition November 1999
1st amendment: October 2001 - 2nd amendment: November 2005 - 3rd amendment: May 2012.

EN 515 Aluminium and aluminium alloys - Wrought products - Temper designations

EN 573-3 Aluminium and aluminium alloys - Chemical composition and form of wrought products - Part 3: Chemical composition and form of products

EN 755-2: Aluminium and aluminium alloys - Extruded rod/bar, tube and profiles - Part 2: Mechanical properties

EN 1863-1 and -2 Glass in building - Heat strengthened soda lime silicate glass

EN 12020-1 Aluminium and aluminium alloys - Extruded precision profiles in alloys EN AW-6060 and EN AW-6063 - Part 1: Technical conditions for inspection and delivery

EN 12020-2 Aluminium and aluminium alloys - Extruded precision profiles in alloys EN AW-6060 and EN AW-6063 - Tolerances on dimensions and form

EN 12210 Windows and doors - Resistance to wind load - Classification

EN 12152 Curtain walling - Air permeability - Performance requirements and classification

EN 12154 Curtain walling - Watertightness - Performance requirements and classification

EN 12207 Windows and doors - Air permeability - Classification

EN 12237 Windows and doors - Watertightness - Classification

EN 13116 Curtain walling - Resistance to wind load - Performance requirements

EN ISO 2143 Anodizing of aluminium and its alloys - Estimation of loss of absorptive power of anodic oxidation coatings after sealing - Dye-spot test with prior acid treatment

EN ISO 2931 Anodizing of aluminium and its alloys - Assessment of quality of sealed anodic oxidation coatings by measurement of admittance

EN ISO 3210 Anodizing of aluminium and its alloys - Assessment of quality of sealed anodic oxidation coatings by measurement of the loss of mass after immersion in phosphoric acid/chromic acid solution

EN ISO 3506 Mechanical properties of corrosion-resistant stainless steel fasteners

EN ISO 10077-2 Thermal performance of windows, doors and shutters - Calculation of thermal transmittance - Numerical method for frames

EN ISO 13788 Hygrothermal performance of building components and building elements - Internal surface temperature to avoid critical surface humidity and interstitial condensation - Calculation methods

EN ISO 12361 Thermal performance of curtain walling - Calculation of thermal transmittance

UBAtc asbl is a non-profit organization according to Belgian law. It is a Technical Assessment Body notified by the Belgian notifying authority, the Federal Public Services Economy, SMEs, Self-Employed and Energy, on 17 July 2013 in the framework of Regulation (EU) No 305/2011 of the European Parliament and of the Council of 9 March 2011 laying down harmonised conditions for the marketing of construction products and repealing Council Directive 89/106/EEC and is member of the European Organisation for Technical Assessment, EOTA (www.eota.eu).

This European Technical Assessment has been issued by UBAtc asbl on the basis of the technical work carried out by the Assessment Operator, BCCA.

On behalf of UBAtc asbl,



Peter Wouters,
Director

On behalf of the Assessment Operator, BCCA, responsible for the technical content of the ETA,



Benny De Blaere,
Director general

The most recent version of this European Technical Assessment may be consulted on the UBAtc website (www.ubatc.be).

Annex I

Figures

Frame: 034.0162.XX

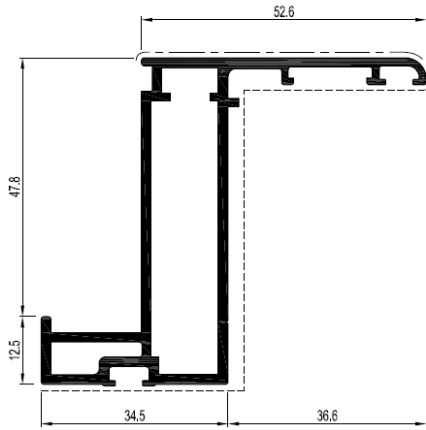

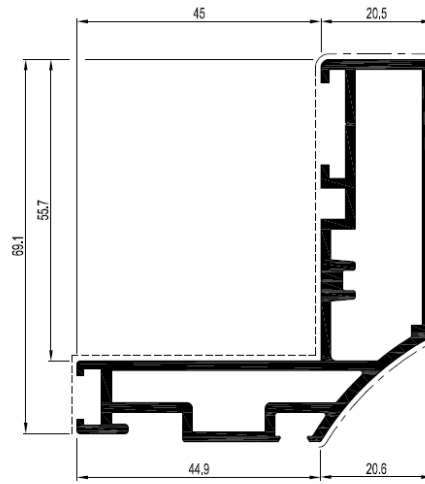

Vent: 034.0163.XX

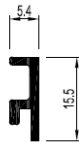

Adaptor profile: 034.1116.17

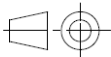

Note: This is a work drawing of REYNAERS ALUMINIUM N.V. without any value, which can not be used for the development of any product.

	WORKDRAWING Product name: CW 50-SG			Structural sealant support frame profiles Canceled Replaces —
	Scale for format A4 1:1	Designed MH	Date 26.09.2011	

034.0161.XX
Double glass frame

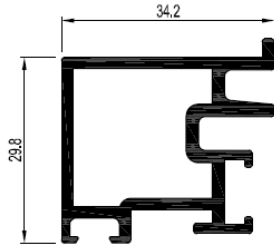

Adaptor profile: 034.1116.17



034.0165.XX
Single glass frame

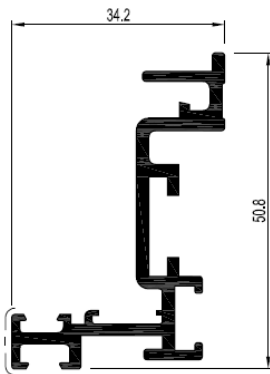

034.0166.XX
Single glass frame

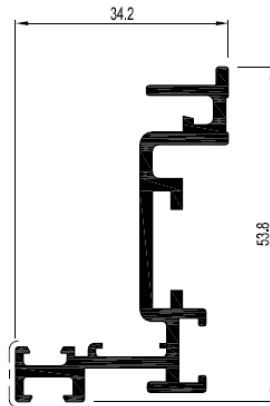

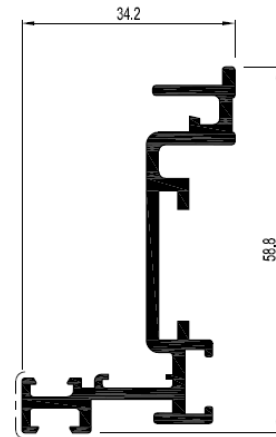

034.0167.XX
Single glass frame



030.3864.XX
Glazing bead

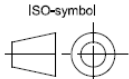

Note: This is a work drawing of REYNAERS ALUMINIUM N.V. without any value, which can not be used for the development of any product.

	WORKDRAWING Product name: CW 50-SG		Structural sealant support frame profiles		Cancelled —
	Scale for format A4 1:1	Designed MH	Date 26.09.2011		
Drawing Name Figure 1 b					

073.7290.39

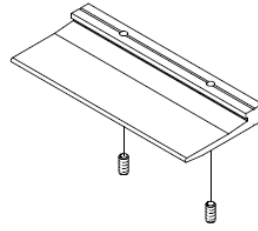
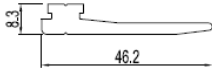

073.7291.39

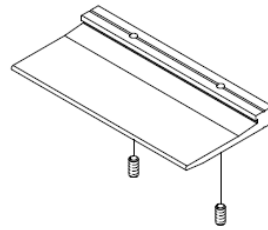
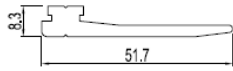

073.7292.39

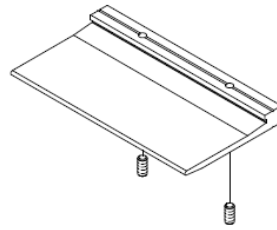
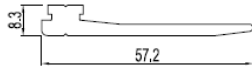

073.7293.39

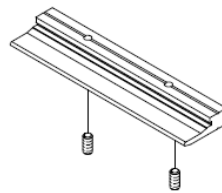
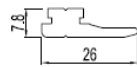

Note: This is a work drawing of REYNAERS ALUMINIUM N.V. without any value, which can not be used for the development of any product.

	WORKDRAWING Product name: CW 50-SG		Mechanical self - weight supports		Cancelled —
					Replaces —
Scale for format A4	Designed MH	Date 26.09.2011			Drawing Name Figure 2

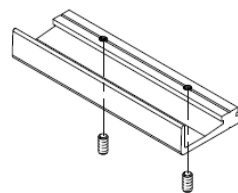
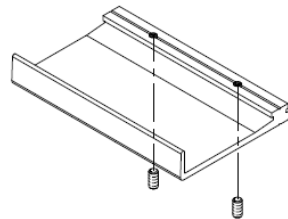
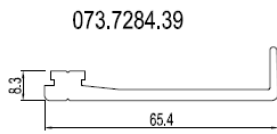
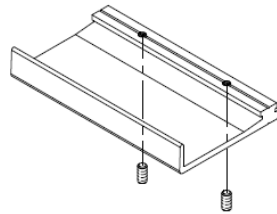
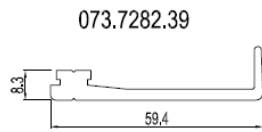
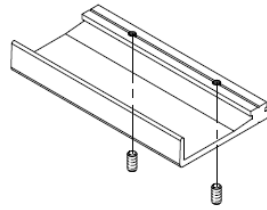
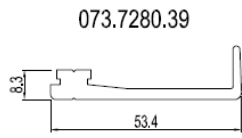

Note: This is a work drawing of REYNAERS ALUMINIUM N.V., without any value, which can not be used for the development of any product.

	WORKDRAWING Product name: CW 50-SG		Retaining devices	Cancelled —
				Replaces —
Scale for format A4	Designed MH	Date 26.09.2011		Drawing Name Figure 3

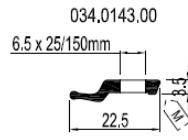
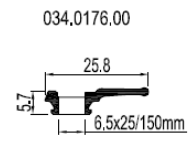
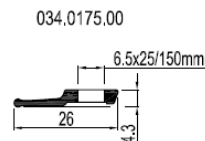
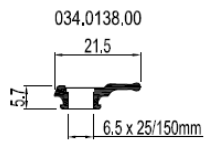
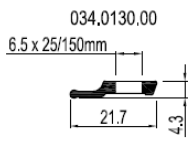

2.5°

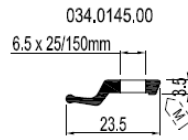
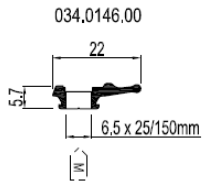

7.5°

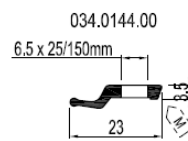
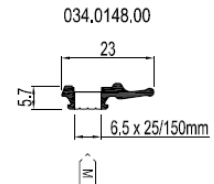

5°

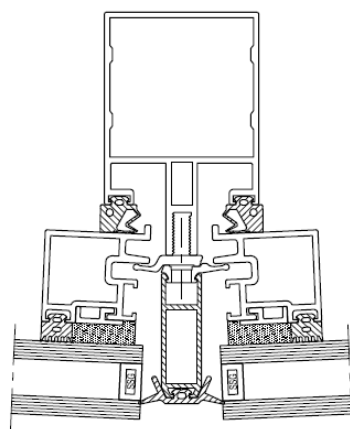
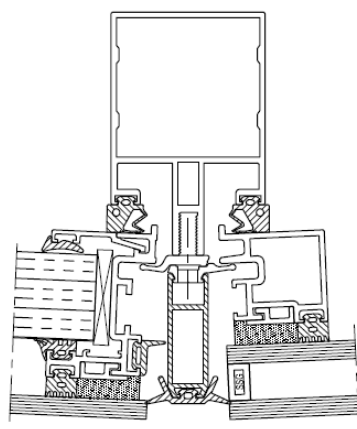
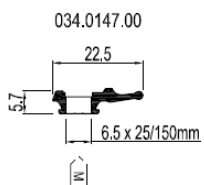

Note: This is a work drawing of REYNAERS ALUMINIUM N.V. without any value, which can not be used for the development of any product.

	WORKDRAWING Product name: CW 50-SG		Anchorage profiles		Cancelled
					Replaces
Scale for format A4	Designed MH	Date 26.09.2011			Drawing Name Figure 4 a

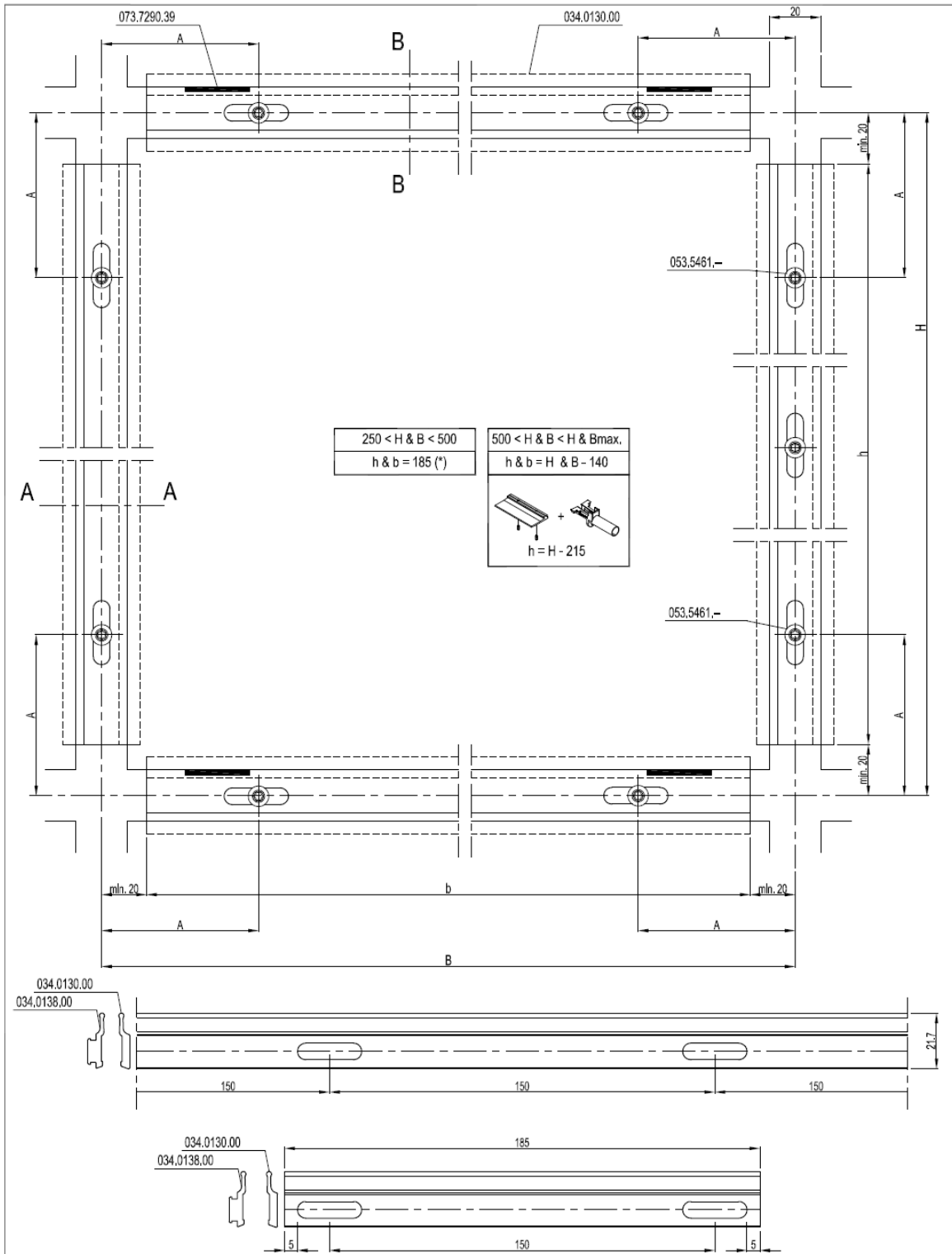

Note: This is a work drawing of REYNAERS ALUMINIUM N.V. without any value, which can not be used for the development of any product.

ISO-symbol 	WORKDRAWING Product name: CW 50-SG	Assembly drawing anchorage profiles		Cancelled —
				Replaces —
Scale for format A4	Designed MH	Date 26.09.2011	Drawing Name Figure 4 b	

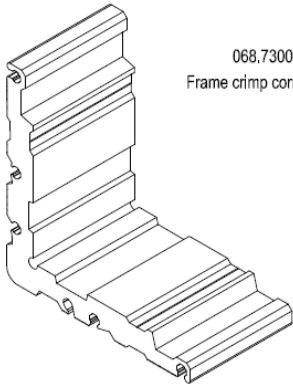

068.7300.00
Frame crimp corner cleat

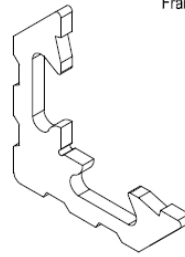

068.7320.00
Frame crimp corner cleat

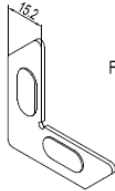

060.7722.-
Frame rebate support

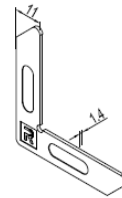

060.8721.-
Frame rebate support

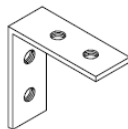

068.6094.00
Frame rebate support

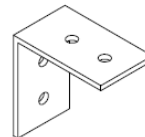

068.6109.00
Frame rebate support

Note: This is a work drawing of REYNAERS ALUMINIUM N.V. without any value, which can not be used for the development of any product.

 Scale for format A4	WORKDRAWING Product name: CW 50-SG		Corner connections overview		Cancelled —
	Designed MH	Date 11.10.2011			Drawing Name Figure 5 a

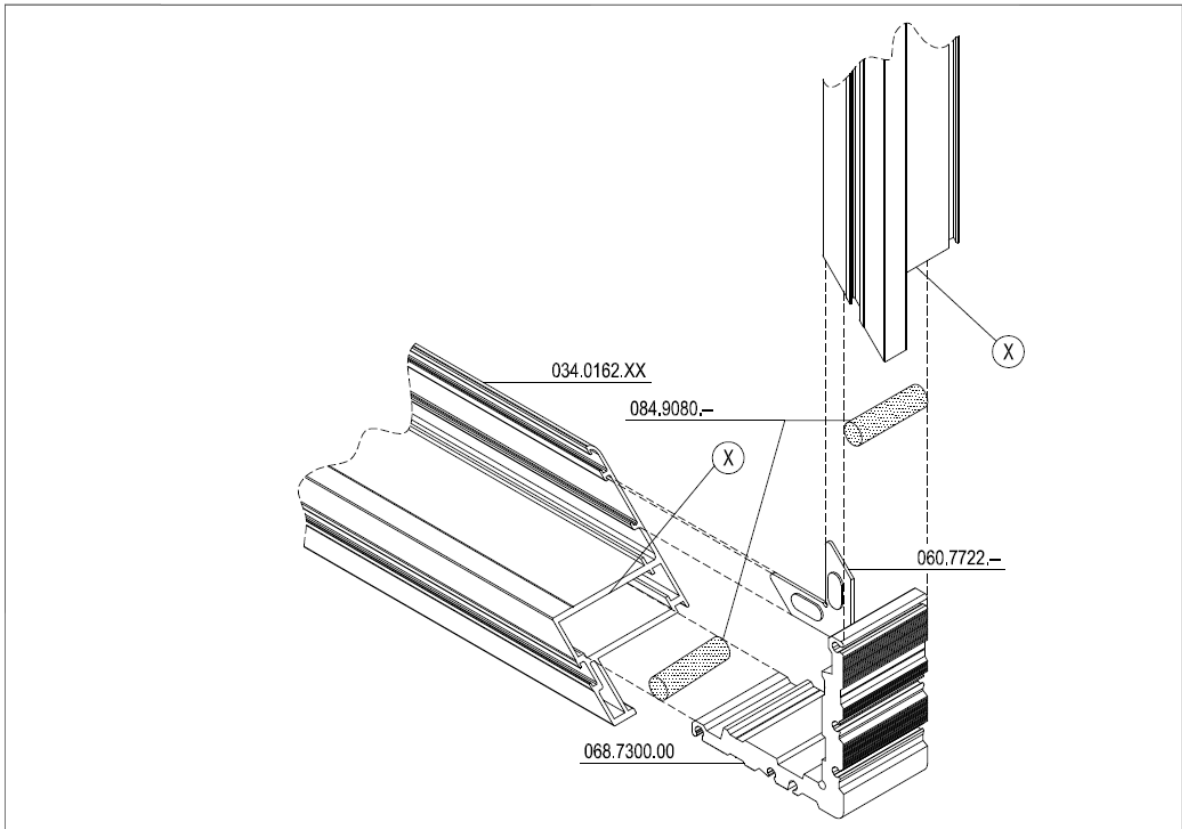



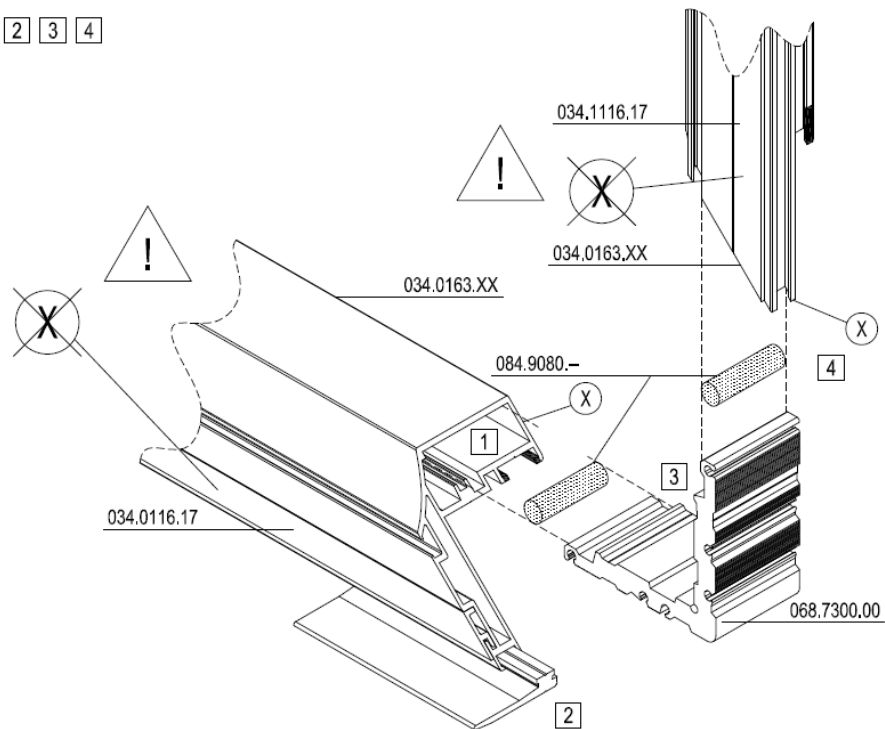



Assembly order 1 2 3 4
 Sealing agent X



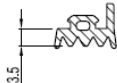
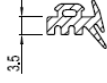

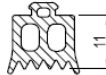
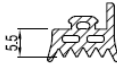
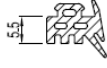

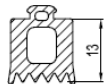
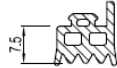

Note: This is a work drawing of REYNAERS ALUMINIUM N.V. without any value, which can not be used for the development of any product.

ISO-symbol 	WORKDRAWING Product name: CW 50-SG		Corner assembly - principle		Cancelled —
	Scale for format A4	Designed MH	Date 11.10.2011		
				Drawing Name Figure 5 b	

Figure 7b

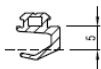
<p>080.9810.04 EPDM seal gasket</p> 	<p>080.9815.04 EPDM seal gasket</p> 	<p>080.9740.04 EPDM seal gasket</p> 	<p>080.9514.04 EPDM seal gasket</p> 
<p>080.9871.04 EPDM seal gasket</p> 	<p>080.9876.04 EPDM seal gasket</p> 	<p>080.9741.04 EPDM seal gasket</p> 	<p>080.9515.04 EPDM seal gasket</p> 
<p>080.9812.04 EPDM seal gasket</p> 	<p>080.9817.04 EPDM seal gasket</p> 	<p>080.9742.04 EPDM seal gasket</p> 	

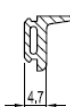
<p>080.9300.04 EPDM gasket (spacer)</p> 	<p>080.9303.04 EPDM gasket (spacer)</p> 	<p>080.9937.04 EPDM weather seal gasket</p> 	<p>080.9938.04 EPDM weather seal gasket</p> 
<p>080.9444.04 EPDM weather seal gasket</p> 	<p>080.9360.04 EPDM seal gasket</p> 	<p>080.9801.04 EPDM seal gasket</p> 	

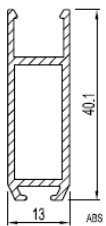
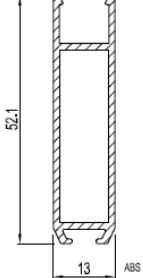

<p>034.0170.04 Gasket support profile</p> 	<p>034.0171.04 Gasket support profile</p> 
---	---

Note: This is a work drawing of REYNAERS ALUMINIUM N.V. without any value, which can not be used for the development of any product.

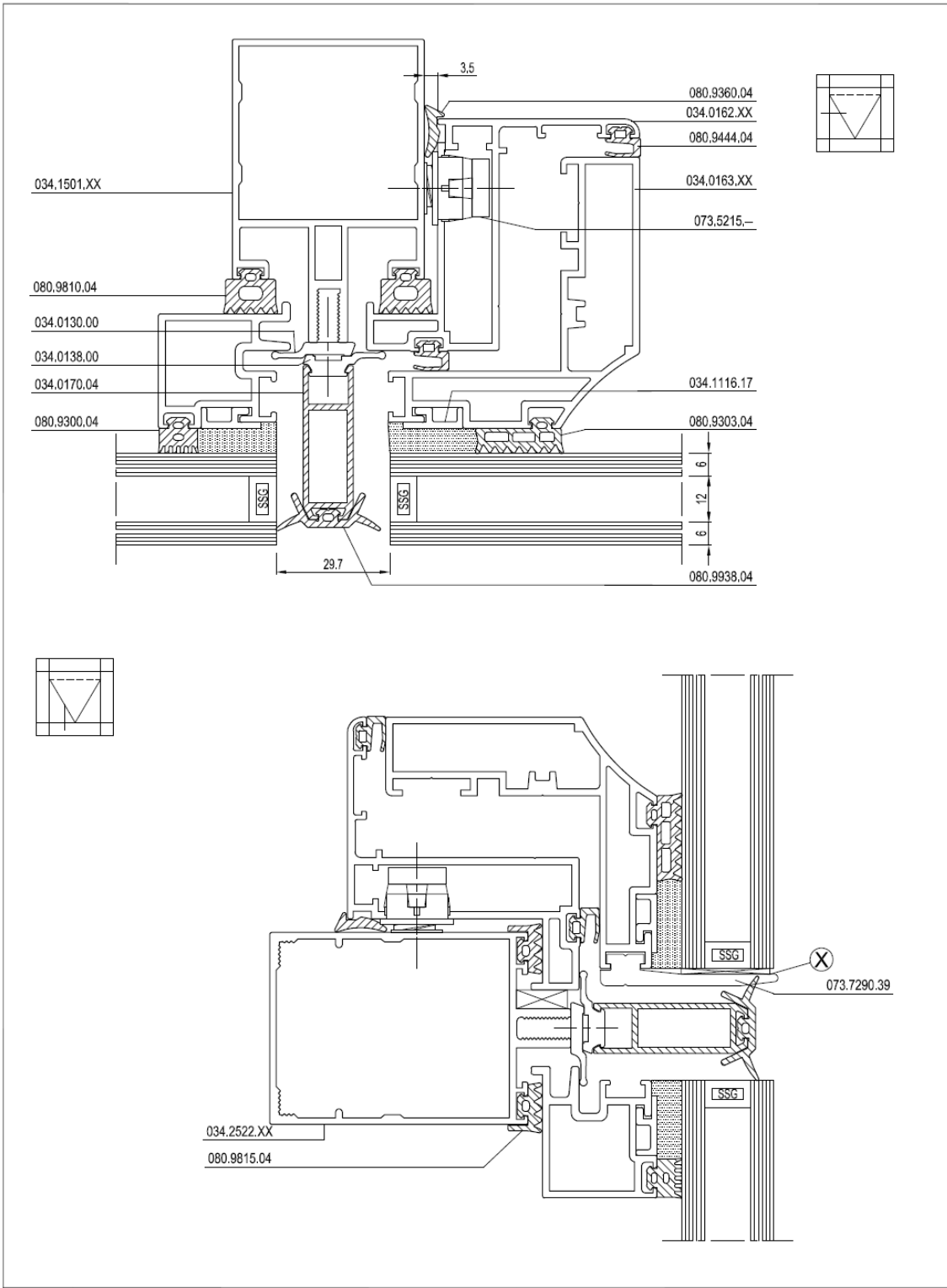
	<p>WORKDRAWING Product name: CW 50-SG</p>	<p>EPDM gaskets and gaskets supports</p>	<p>Cancelled — Replaces —</p>
<p>Scale for format A4</p>	<p>Designed MH</p>	<p>Date 12.10.2011</p>	<p>Drawing Name Figure 6</p>



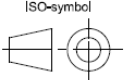

Note: This is a work drawing of REYNAERS ALUMINIUM N.V., without any value, which can not be used for the development of any product.

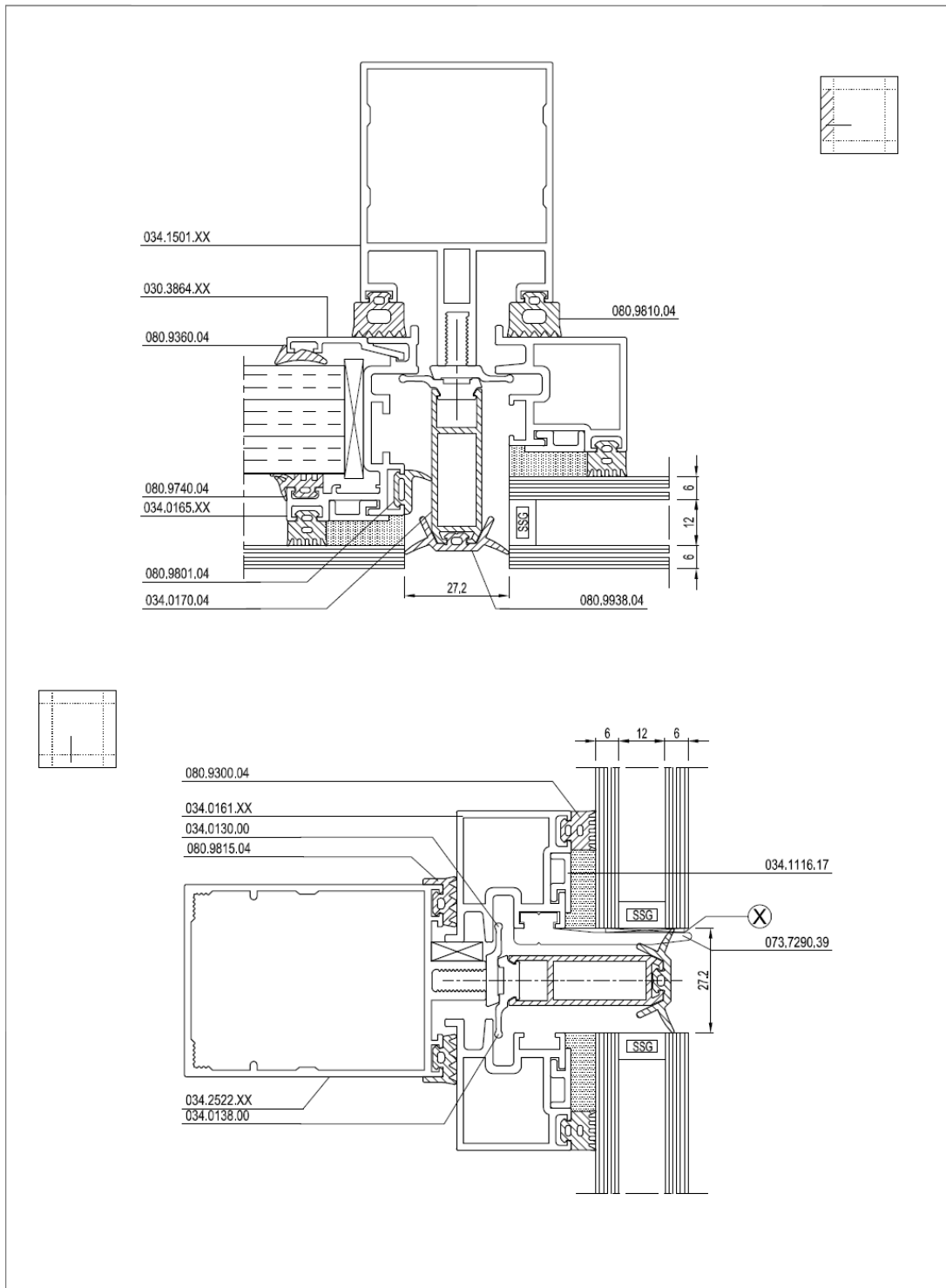
	WORKDRAWING		Top Hung window	Cancelled —
	Product name: CW 50-SG			Replaces —
Scale for format A4	Designed MH	Date 12.10.2011		Drawing Name Figure 7 a

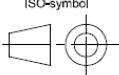

Note: This is a work drawing of REYNAERS ALUMINIUM N.V. without any value, which can not be used for the development of any product.

ISO-symbol 	WORKDRAWING Product name: CW 50-SG		Fixed panel	Cancelled —
				Replaces —
Scale for format A4	Designed MH	Date 12.10.2011		Drawing Name Figure 7 b

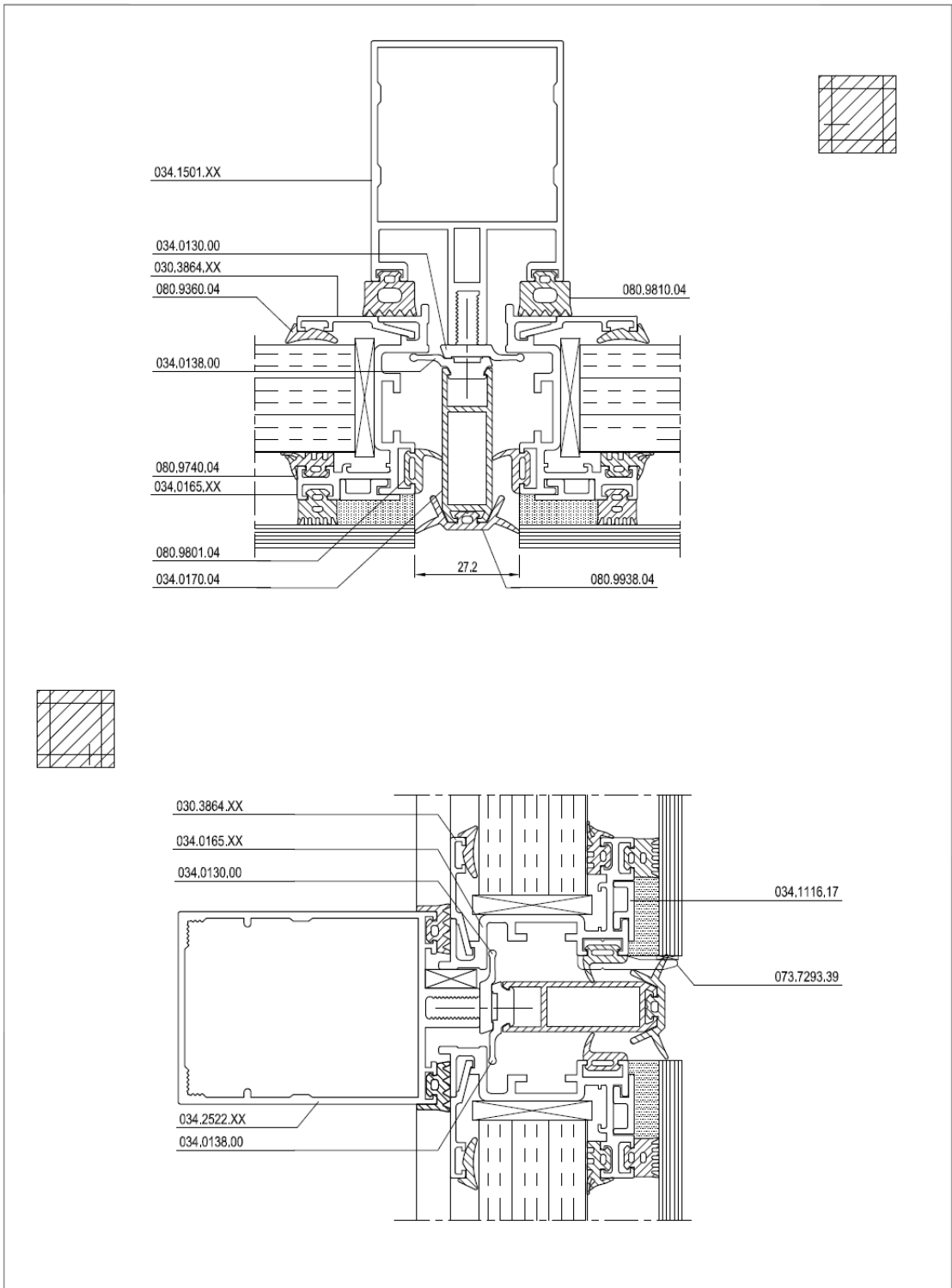

Note: This is a work drawing of REYNAERS ALUMINIUM N.V. without any value, which can not be used for the development of any product.

ISO-symbol  Scale for format A4	WORKDRAWING Product name: CW 50-SG		Spandrel glazing	Cancelled —
	Designed MH	Date 12.10.2011		Drawing Name Figure 7 c

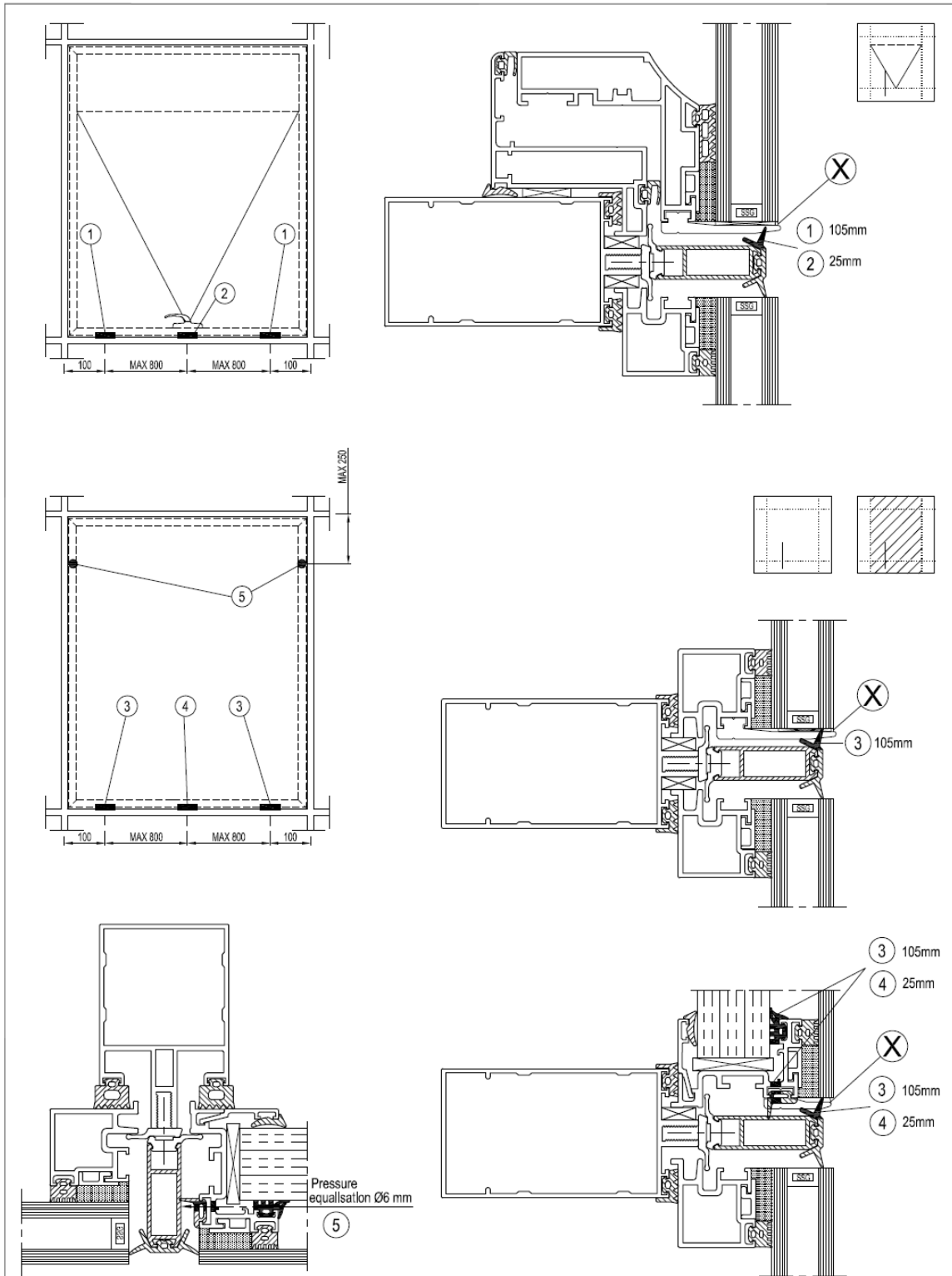

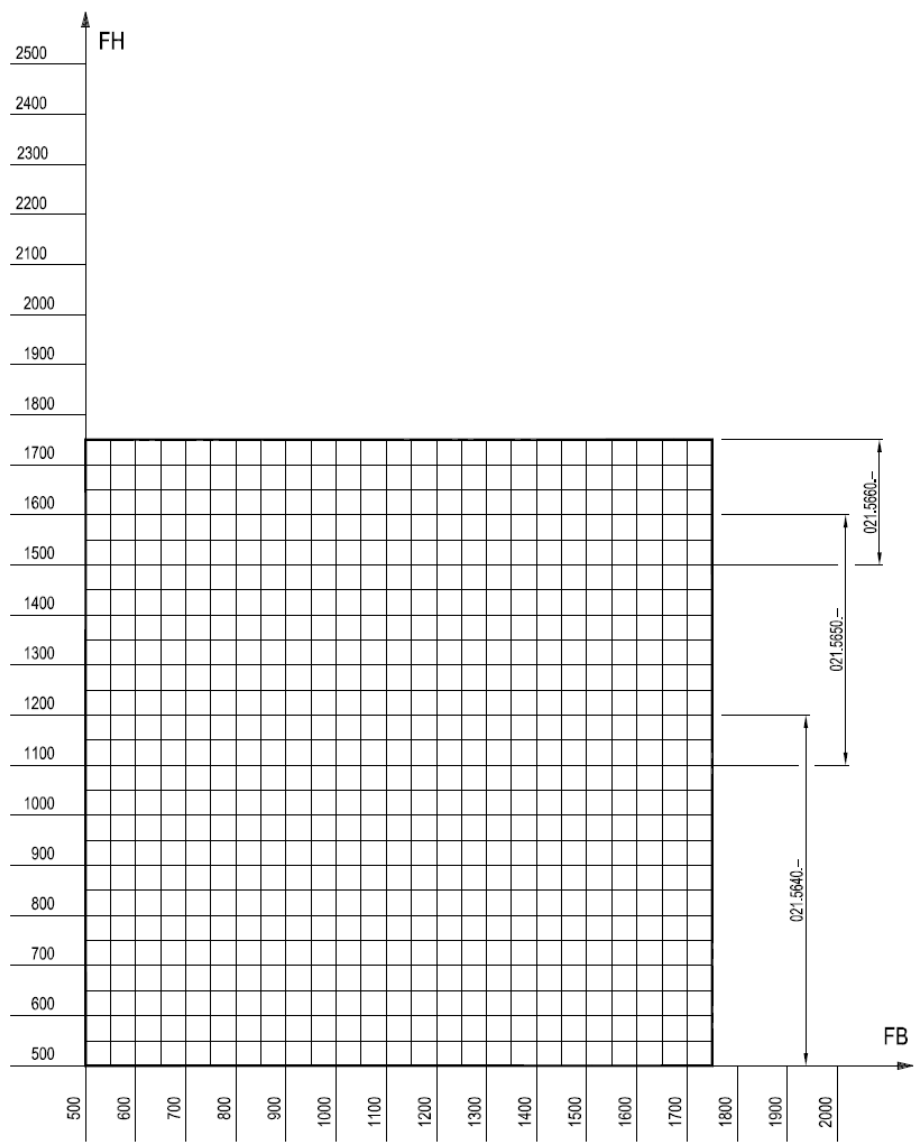
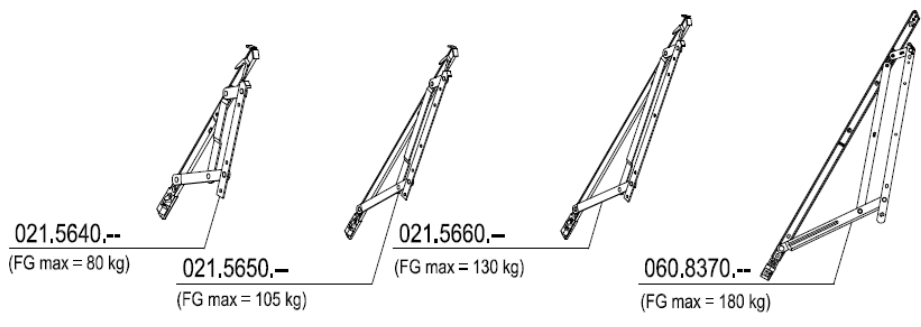

Note: This is a work drawing of REYNAERS ALUMINIUM N.V. without any value, which can not be used for the development of any product.

ISO-symbol 	WORKDRAWING Product name: CW 50-SG		Drainage and ventilation		Cancelled —
	Scale for format A4	Designed MH	Date 13.10.2011		
Drawing Name Figure 8					

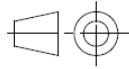

Note: This is a work drawing of REYNAERS ALUMINIUM N.V. without any value, which can not be used for the development of any product.

ISO-symbol 	WORKDRAWING Product name: CW 50-SG		Top Hung window maximum dimensions	Cancelled
				Replaces
Scale for format A4	Designed MH	Date 13.10.2011		Drawing Name Figure 9

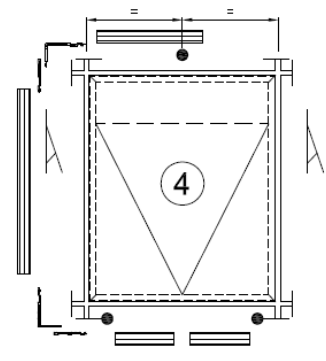
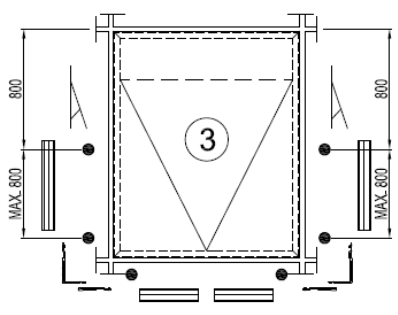
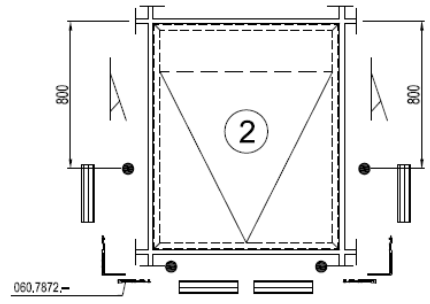
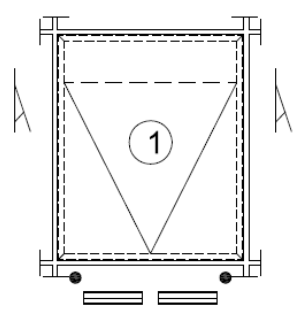
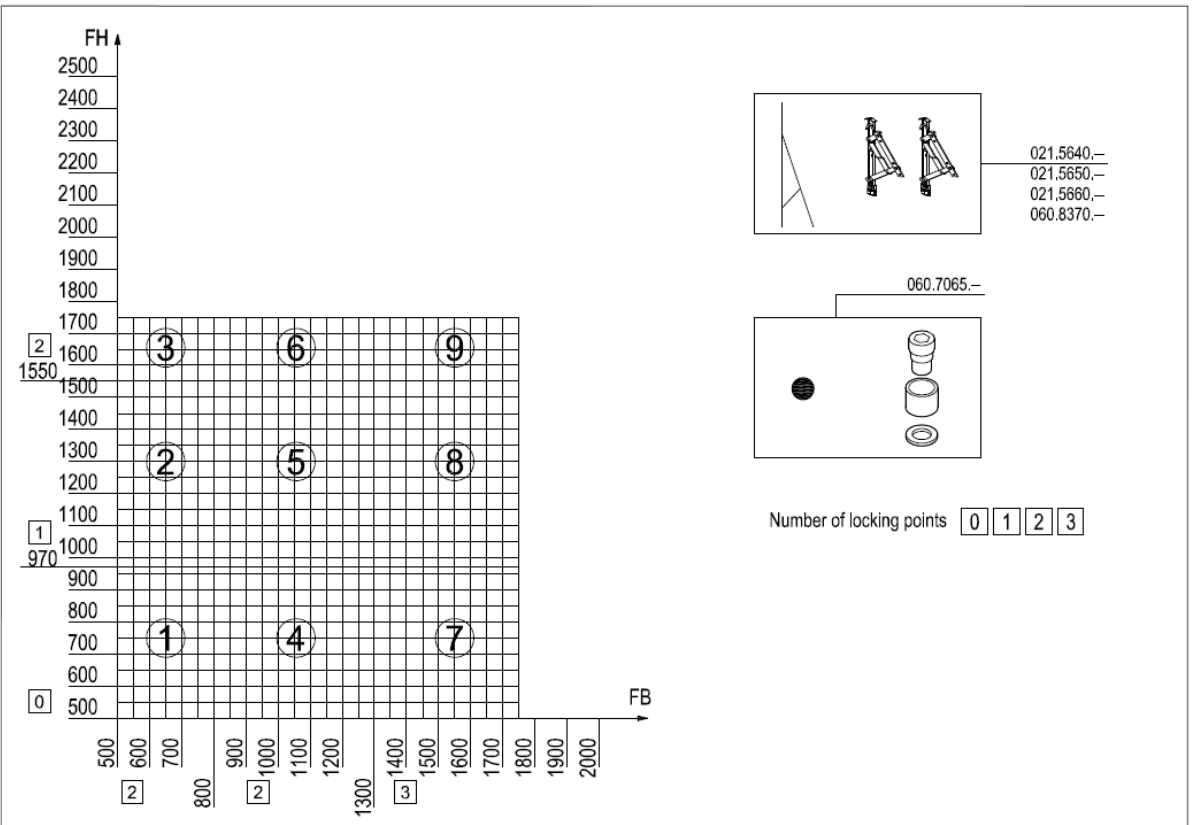

<p>Note: This is a work drawing of REYNAERS ALUMINIUM N.V. without any value, which can not be used for the development of any product.</p>			
<p>ISO-symbol</p>	<p>WORKDRAWING</p> <p>Product name: CW 50-SG</p>		<p>Position and number of locking points</p>
<p>Scale for format A4</p>	<p>Designed</p> <p>MH</p>	<p>Date</p> <p>13.10.2011</p>	<p>Cancelled</p> <p>—</p> <p>Replaces</p> <p>—</p>
		<p>Drawing Name</p> <p>Figure 10 a</p>	

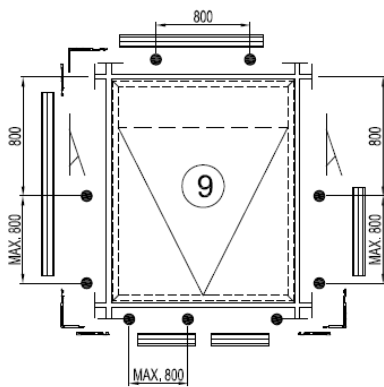
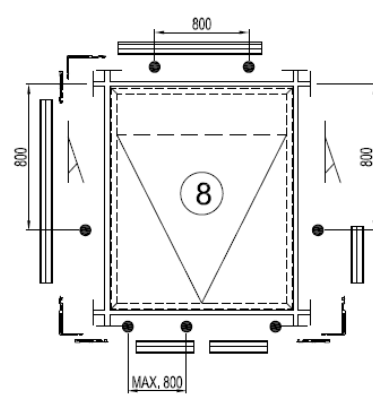
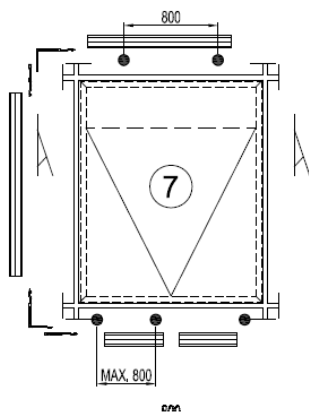
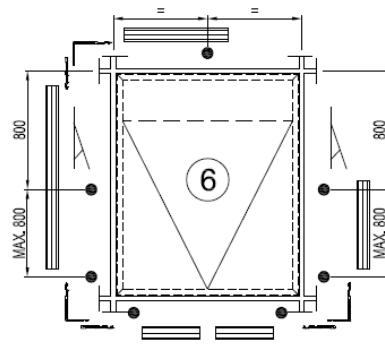
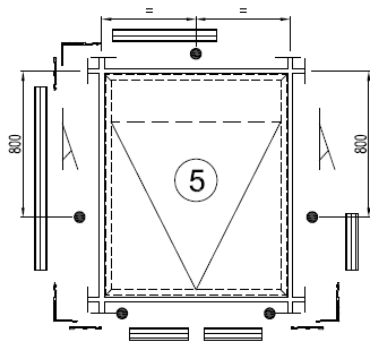

Note: This is a work drawing of REYNAERS ALUMINIUM N.V. without any value, which can not be used for the development of any product.

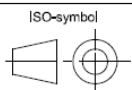

WORKDRAWING

Product name: CW 50-SG

Position and number of locking points

Cancelled
—
Replaces
—

Scale for
format A4

Designed
MH

Date
13.10.2011



Drawing Name
Figure 10 b

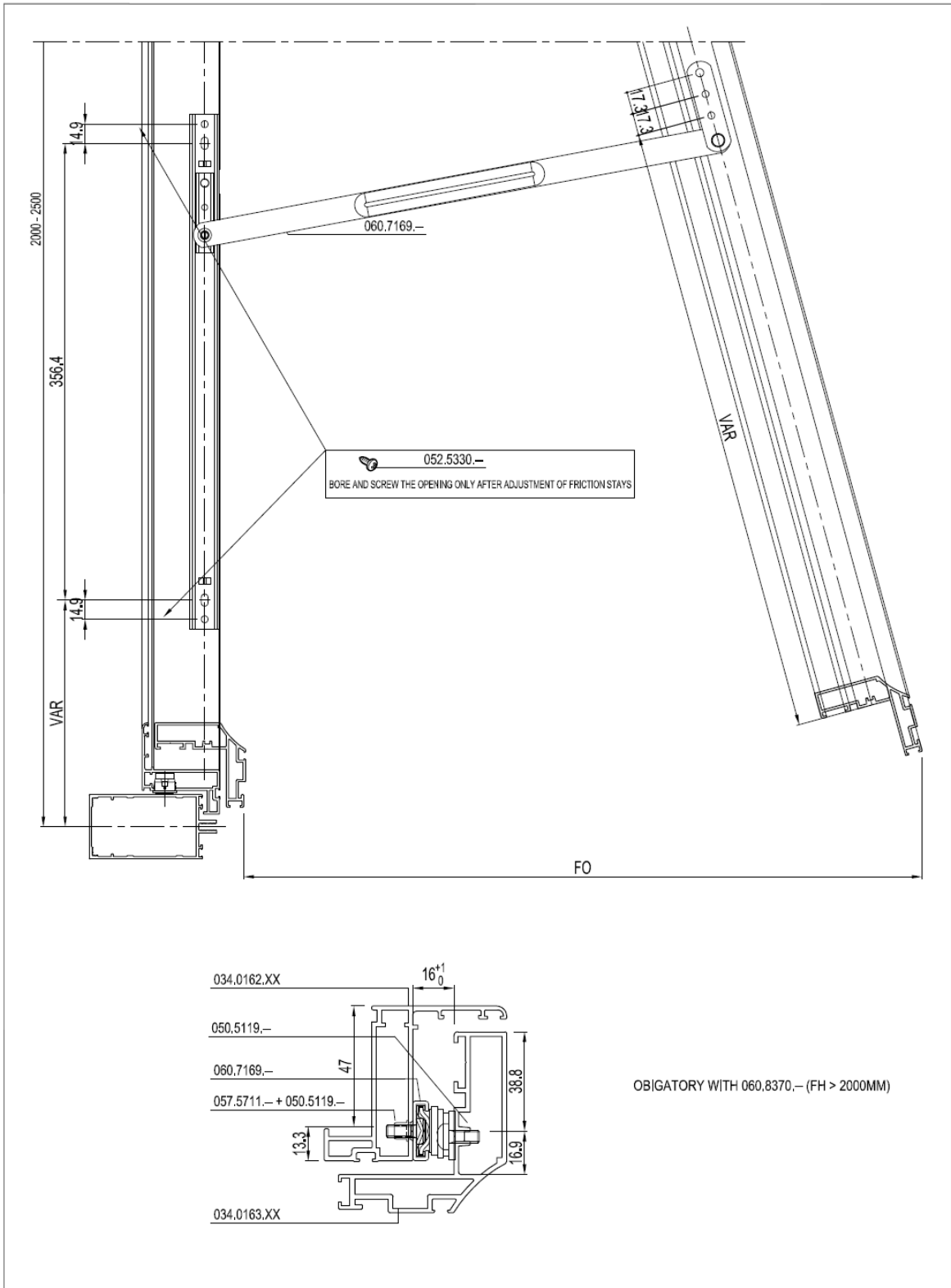

Note: This is a work drawing of REYNAERS ALUMINIUM N.V. without any value, which can not be used for the development of any product.

	<h1>WORKDRAWING</h1>		<h2>Opening restrictor Top Hung window</h2>		Cancelled
	Product name: CW 50-SG				Replaces
Scale for format A4	Designed MH	Date 13.10.2011			Drawing Name Figure 10 c